

2450

SourceMeter® SMU Instrument



The Model 2450 is Keithley's next-generation SourceMeter source measure unit (SMU) Instrument that truly brings Ohm's law (current, voltage, and resistance) testing right to your fingertips. Its innovative graphical user interface (GUI) and advanced, capacitive touchscreen technology allow intuitive usage and minimize the learning curve to enable engineers and scientists to learn faster, work smarter, and invent easier. The 2450 is the SMU for everyone: a versatile instrument, particularly well-suited for characterizing modern scaled semiconductors, nano-scale devices and materials, organic semiconductors, printed electronics, and other small-geometry and low-power devices. All this combined with Keithley SMU precision and accuracy allow users to Touch, Test, Invent™ with the new favorite go-to instrument in the lab for years to come.

- Capabilities of analyzers, curve tracers, and I-V systems at a fraction of their cost.
- Five-inch, high resolution capacitive touchscreen GUI
- 0.012% basic measure accuracy with 6½-digit resolution
- Enhanced sensitivity with new 20mV and 10nA source/measure ranges
- Source and sink (4-quadrant) operation
- Four "Quickset" modes for fast setup and measurements
- Built-in, context-sensitive front panel help
- Front panel input banana jacks; rear panel input triaxial connections
- 2450 SCPI and TSP® scripting programming modes
- Model 2400 SCPI-compatible programming mode
- Front panel USB memory port for data/programming/configuration I/O

Learn Faster, Work Smarter, Invent Easier

Unlike conventional instruments with dedicated pushbutton technology and small, obscure, limited-character displays, the 2450 features a five-inch, full-color, high resolution touchscreen that facilitates ease of use, learning, and optimizes overall speed and productivity. A simple icon-based menu structure reduces configuration steps by as much as 50 percent and eliminates the cumbersome multi-layer menu structures typically used on soft-key instruments. Built-in, context-sensitive help enables intuitive operation and minimizes the need to review a separate manual. These capabilities combined with its application versatility make the 2450 the SMU instrument inherently easy to use for basic and advanced measurement applications, regardless of your experience level with SMU instruments.



2450 main home screen.

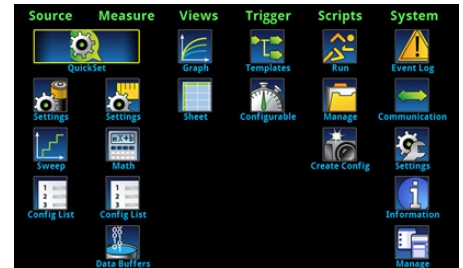

View of 2450 menu.

Fourth-Generation, All-in-One SMU Instrument

The 2450 is the fourth-generation member of Keithley's award-winning SourceMeter family of SMU instruments and leverages the proven capabilities of the Model 2400 SourceMeter SMU Instrument. It offers a highly flexible, four-quadrant voltage and current source/load coupled with precision voltage and current meters. This all-in-one instrument can be used as a:

- Precision power supply with V and I readback
- True current source
- Digital multimeter (DCV, DCI, ohms, and power with 6½-digit resolution).
- Precision electronic load
- Trigger controller

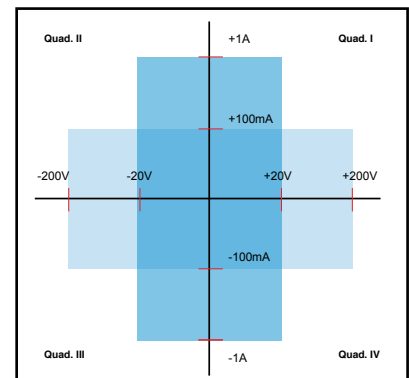

2450 power envelope.

1.888.KEITHLEY (U.S. only)

www.keithley.com

A Greater Measure of Confidence

KEITHLEY
A Tektronix Company

Model 2450 SourceMeter® SMU Instrument

SMU INSTRUMENTS

2450

Ordering Information

- 2450** 200V, 1A, 20W SourceMeter Instrument
- 2450-NFP** 200V, 1A, 20W SourceMeter Instrument, with No Front Panel
- 2450-RACK** 200V, 1A, 20W SourceMeter Instrument, without Handle
- 2450-NFP-RACK** 200V, 1A, 20W SourceMeter Instrument, with No Front Panel and No Handle

Accessories Supplied

- 8608** High Performance Test Leads
- USB-B-1** USB Cable, Type A to Type B, 1m (3.3 ft)
- CS-1616-3** Safety Interlock Mating Connector
- CA-180-3A** TSP-Link/Ethernet Cable
- Documentation CD
- 2450 QuickStart Guide
- Test Script Builder Software (supplied on CD)
- KickStart Startup Software (supplied on CD)
- LabVIEW and IVI Drivers available at www.keithley.com

SourceMeter® SMU Instrument

Model 2400	Model 2450
V-Ranges: 200mV – 200V	V-Ranges: 20mV – 200V
I-Ranges: 1µA – 1A	I-Ranges: 10nA – 1A
0.012% Basic Accuracy	0.012% Basic Accuracy
Wideband Noise: 4mV _{rms} Typ.	Wideband Noise: 2mV _{rms} Typ.
Sweep Types: Linear, Log, Custom, Source-Memory	Sweep Types: Linear, Log, Dual Linear, Dual Log, Custom, Source-Memory (SCPI 2400 Mode)
5000 Point Reading Buffer	>250,000 Point Reading Buffer
>2000 Readings/Sec.	>3000 Readings/Sec.
SCPI Programming	SCPI (2400 + 2450) + TSP Programming
GPIB	GPIB, USB, Ethernet (LXI)
Front/Rear Banana Jacks	Front: Banana Jacks, Rear: Triax

Comparison of Model 2400 vs Model 2450.

Ease of Use Beyond the Touchscreen

In addition to its five-inch, color touchscreen, the 2450 front panel has many features that supplement its speed, user-friendliness, and learnability, including a USB 2.0 memory I/O port, a HELP key, a rotary navigation/control knob, a front/rear input selector button, and banana jacks for basic bench applications. The USB 2.0 memory port supports easy data storing, saving instrument configurations, loading test scripts, and system upgrades. Plus, all front panel buttons are backlit to enhance visibility in low-light environments.

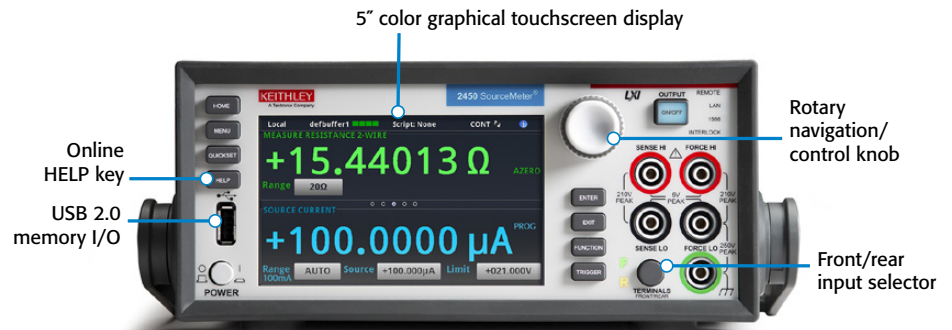

Model 2450 front panel with high resolution, capacitive touchscreen.

Four “Quickset” modes simplify user setup. With one touch, the instrument can be quickly configured for various operating modes without the need to configure the instrument indirectly for this operation.

Comprehensive Built-in Connectivity

Rear panel access to rear-input triax connectors, remote control interfaces (GPIB, USB 2.0, and LXI/Ethernet), D-sub 9-pin digital I/O port (for internal/external trigger signals and handler control), instrument interlock control, and TSP-Link® jacks enables easy configuration of multiple instrument test solutions and eliminates the need to invest in additional adapter accessories.

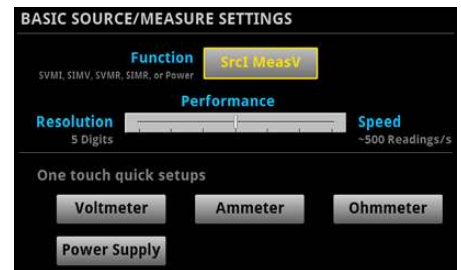

Quickset modes enable fast setup and time to measurements.

1.888.KEITHLEY (U.S. only)

www.keithley.com

KEITHLEY
A Tektronix Company

2450

SourceMeter® SMU Instrument

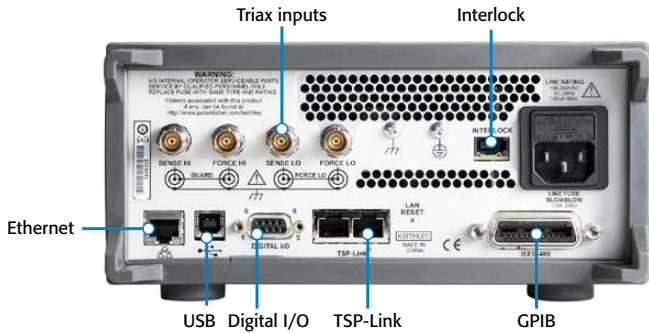

Rear panel connections are optimized for signal integrity.

Convert Raw Data to Information

The 2450 provides a full plotting and sheet view to display sweeps, measurement data, and charting right on the screen. It also supports exporting to a spreadsheet for further analysis, dramatically improving productivity for research, bench-top testing, device qualification, and debugging.

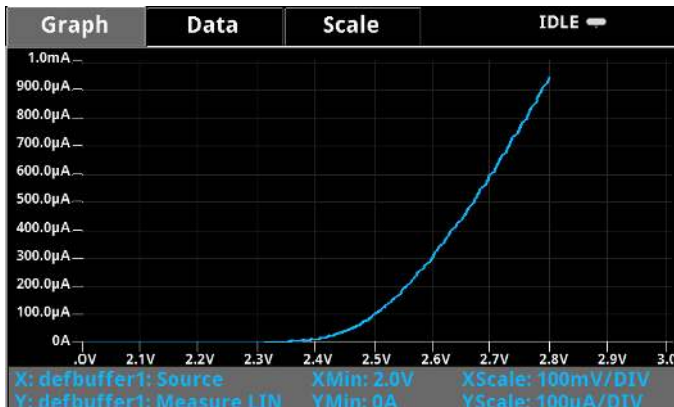

DATA SHEET

Buffer: defbuffer1 [Jump] [Refresh]

Time	Source	Measure	
1	05/08 09:50	0	-2.51326e-07
2	09:50:03.6	0.1	6.38803e-05
3	09:50:05.3	0.2	0.000127991
4	09:50:05.8	0.3	0.00019225
5	09:50:06.4	0.4	0.000256259
6	09:50:06.9	0.5	0.000320488
7	09:50:07.5	0.6	0.000384533
8	09:50:08.0	0.7	0.000448547
9	09:50:08.6	0.8	0.000512793
10	09:50:09.1	0.9	0.000576823
11	09:50:09.7	1	0.000641066

Full data display, charting, and export to a spreadsheet lets you convert raw data to useful information.

TYPICAL APPLICATIONS

Ideal for current/voltage characterization and functional test of a wide range of today's modern electronics and devices, including:

- **Nanomaterials and Devices**
 - Graphene
 - Carbon nanotubes
 - Nanowires
 - Low power nanostructures
- **Semiconductor Structures**
 - Wafers
 - Thin films
- **Organic Materials and Devices**
 - E-inks
 - Printable electronics
- **Energy Efficiency and Lighting**
 - LEDs/AMOLEDs
 - Photovoltaics/Solar Cells
 - Batteries
- **Discrete and Passive Components**
 - Two-leaded: Resistors, diodes, zener diodes, LEDs, disk drive heads, sensors
 - Three-leaded: Small signal bipolar junction transistors (BJTs), field effect transistors (FETs), and more
- **Material Characterization**
 - Resistivity
 - Hall Effect

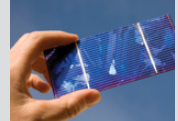
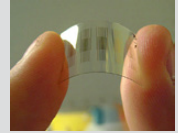
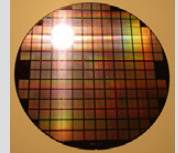
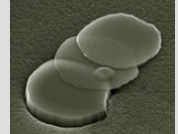
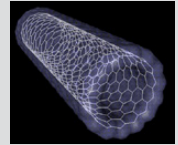

TriggerFlow™ Building Blocks for Instrument Control and Execution

The 2450 incorporates Keithley's new TriggerFlow triggering system that allows user control of instrument execution. Similar to developing a flow chart, TriggerFlow diagrams are created using four fundamental building blocks:

- **Wait** – Waits for an event to occur before the flow continues
- **Branch** – Branches when a condition has been satisfied
- **Action** – Initiates an action in the instrument, for example, measure, source, delay, set digital I/O, etc.
- **Notify** – Notifies other equipment that an event has occurred

1.888.KEITHLEY (U.S. only)

www.keithley.com

A Greater Measure of Confidence

KEITHLEY
A Tektronix Company

Model 2450 SourceMeter® SMU Instrument

SMU INSTRUMENTS

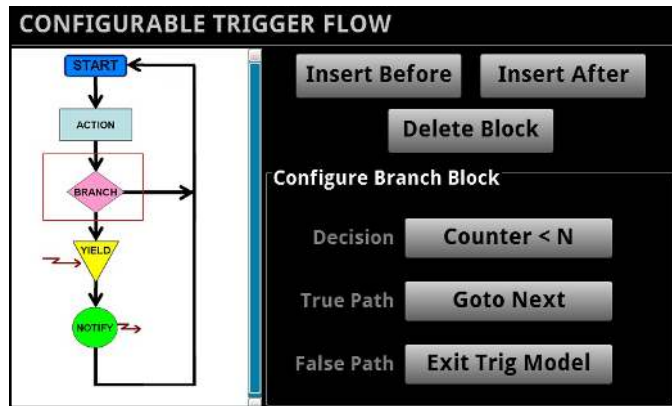

TriggerFlow building blocks let users create very simple to very complex triggering models.

A TriggerFlow model using a combination of these building blocks can be created from the front panel or by sending remote commands. With the TriggerFlow system, users can build triggering models from very simple to complex with up to 255 block levels. The 2450 also includes basic triggering functions, including immediate, timer, and manual triggering.

Unmatched System Integration and Programming Flexibility

When the 2450 is integrated as part of a multi-channel I-V test system, the Test Script Processor (TSP®) embedded scripting capability allows test scripts to be run by the instrument, enabling the user to create powerful measurement applications with significantly reduced development times. TSP technology also offers channel expansion without a mainframe. Keithley's TSP-Link® channel expansion bus, which uses a 100 Base T Ethernet cable, connects multiple 2450 instruments and other TSP instruments such as Keithley's Series 2600B SourceMeter SMU instruments and Series 3700A Switch/Multimeter systems in a master-slave configuration that behaves as one integrated system. The TSP-Link expansion bus supports up to 32 units per GPIB or IP address, making it easy to scale a system to fit an application's particular requirements.

The 2450 also includes a SCPI programming mode that optimizes the instrument's new features, as well as a SCPI 2400 mode that provides backwards compatibility with the existing Model 2400 SourceMeter instrument. Not only does this preserve your 2400 investment, but it also eliminates re-work normally associated with upgrading to a new instrument with new capabilities.

Parallel Test Capability

With the TSP technology in the 2450, multiple devices can be tested in parallel to meet the needs of device research, advanced semiconductor lab applications, and even high throughput production test. This parallel testing capability enables each instrument in the system to run its own complete test sequence, creating a fully multi-threaded test environment. The number of tests that can be run in parallel on a 2450 can be as high as the number of instruments in the system.

Free Instrument Control Start-up Software and Web Interface

KickStart, Keithley's new instrument control non-programming start-up software, lets users start taking measurements in minutes. In most cases, users merely need to make quick measurements, graph the data, and store the data to disk to perform analysis in software environments such as Excel.

KickStart offers the following functionality:

- Instrument configuration control to perform I-V characterization
- Native X-Y graphing, panning, and zooming
- Spreadsheet/tabular viewing of data
- Saving and exporting data for further analysis
- Saving of test setups
- Screenshot capturing of graph
- Annotation of tests
- Command line dialog for sending and receiving data
- HTML help
- GPIB, USB 2.0, Ethernet compliant

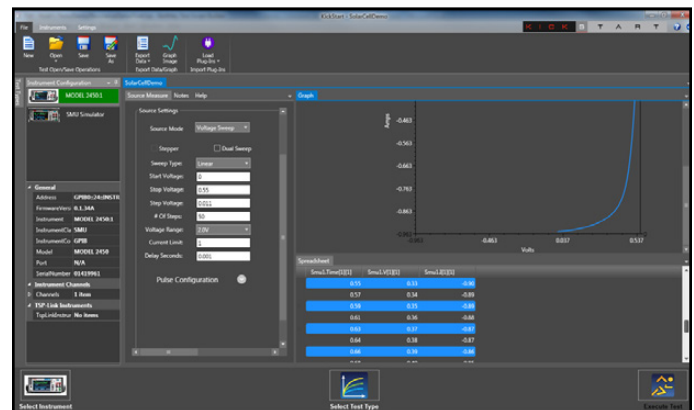

With KickStart start-up software, users are ready to take measurements in minutes.

Simplified Programming with Ready-to-Use Instrument Drivers

For users who want to create their own customized application software, native National Instruments LabVIEW® drivers, IVI-C, and IVI-COM drivers are available at www.keithley.com.

ACCESSORIES AVAILABLE

TEST LEADS AND PROBES

1754	2-wire Universal 10-Piece Test Lead Kit
5804	Kelvin (4-Wire) Universal 10-Piece Test Lead Kit
5805	Kelvin (4-Wire) Spring-Loaded Probes
5806	Kelvin Clip Lead Set
5808	Low Cost Single-pin Kelvin Probe Set
5809	Low Cost Kelvin Clip Lead Set
8605	High Performance Modular Test Leads
8606	High Performance Modular Probe Kit
8608	High Performance Clip Lead Set

CABLES, CONNECTORS, ADAPTERS

237-ALG-2	3-slot Male Triax Connector to 3 Alligator Clips
237-BAN-3A	Triax to Banana Plug
2450-TRX-BAN	Triax to Banana Adapter. Converts the 4 Triax adapters on the rear panel to 5 banana jacks
7078-TRX.*	3-slot, Low Noise Triax Cable
7078-TRX-GND	3-slot Male Triax To BNC Adapter (guard removed)
8607	2-wire, 1000V Banana Cables, 1m (3.3 ft)
CA-18-1	Shielded Dual Banana Cable, 1.2m (4 ft)
CAP-31	Protective Shield/Cap for 3-lug Triax Connectors
CS-1546	Triax 3-lug Special Shorting Plug. Shorts center pin to outer shield
CS-1616-3	Safety Interlock Mating Connector

COMMUNICATION INTERFACES & CABLES

KPCI-488LPA	IEEE-488 Interface for PCI Bus
KUSB-488B	IEEE-488 USB-to-GPIB Interface Adapter
7007-1	Shielded GPIB Cable, 1m (3.3 ft)
7007-2	Shielded GPIB Cable, 1m (6.6 ft)
CA-180-3A	CAT5 Crossover Cable for TSP-Link/Ethernet
USB-B-1	USB Cable, Type A to Type B, 1m (3.3 ft)

TRIGGERING AND CONTROL

2450-TLINK	DB-9 to Trigger Link Connector Adapter.
8501-1	Trigger Link Cable, DIN-to-DIN, 1m (3.3 ft)
8501-2	Trigger Link Cable, DIN-to-DIN, 2m (6.6 ft)

RACK MOUNT KITS

4299-8	Single Fixed Rack Mount Kit
4299-9	Dual Fixed Rack Mount Kit
4299-10	Dual Fixed Rack Mount Kit. Mount one 2450 and one Series 26xxB
4299-11	Dual Fixed Rack Mount Kit. Mount one 2450 and one Series 2400, Series 2000, etc.
2450-BenchKit	Ears and Handle for 2450-NFP-RACK and 2450-RACK models

TEST FIXTURES

8101-PIV	DC Test Fixture
----------	-----------------

SERVICES AVAILABLE

2450-3Y-EW	1 Year Factory Warranty extended to 3 years from date of shipment
2450-5Y-EW	1 Year Factory Warranty extended to 5 years from date of shipment
C/2450-3Y-17025	KeithleyCare® 3 Year ISO 17025 Calibration Plan
C/2450-3Y-DATA	KeithleyCare 3 Year Calibration w/Data Plan
C/2450-3Y-STD	KeithleyCare 3 Year Std. Calibration Plan
C/2450-5Y-17025	KeithleyCare 5 Year ISO 17025 Calibration Plan
C/2450-5Y-DATA	KeithleyCare 5 Year Calibration w/Data Plan
C/2450-5Y-STD	KeithleyCare 5 Year Std. Calibration Plan

Voltage Specifications^{1,2}

Range	Source		Measure ³		
	Resolution	Accuracy (23° ± 5°C) 1 Year ±(% setting + volts)	Noise (RMS) (<10Hz)	Input Resistance	Accuracy (23° ± 5°C) 1 Year ±(% rdg. + volts)
20.00000 mV	500 nV	0.100% + 200 μV	1 μV	10 nV >10 GΩ	0.100% + 150 μV
200.0000 mV	5 μV	0.015% + 200 μV	1 μV	100 nV >10 GΩ	0.012% + 200 μV
2.000000 V	50 μV	0.020% + 300 μV	10 μV	1 μV >10 GΩ	0.012% + 300 μV
20.00000 V	500 μV	0.015% + 2.4 mV	100 μV	10 μV >10 GΩ	0.015% + 1 mV
200.0000 V	5 mV	0.015% + 24 mV	1 mV	100 μV >10 GΩ	0.015% + 10 mV

Current Specifications^{1,2}

Range	Source		Measure ³		
	Resolution	Accuracy (23° ± 5°C) ⁴ 1 Year ±(% setting + amps)	Noise (RMS) (<10Hz)	Voltage Burden	Accuracy (23° ± 5°C) 1 Year ±(% rdg. + amps)
10.00000 nA ⁵	500 fA	0.100% + 100 pA	500 fA	10 fA <100 μV	0.100% + 50 pA
100.0000 nA ⁵	5 pA	0.060% + 150 pA	500 fA	100 fA <100 μV	0.060% + 100 pA
1.000000 μA	50 pA	0.025% + 400 pA	5 pA	1 pA <100 μV	0.025% + 300 pA
10.00000 μA	500 pA	0.025% + 1.5 nA	40 pA	10 pA <100 μV	0.025% + 700 pA
100.0000 μA	5 nA	0.020% + 15 nA	400 pA	100 pA <100 μV	0.020% + 6 nA
1.000000 mA	50 nA	0.020% + 150 nA	5 nA	1 nA <100 μV	0.020% + 60 nA
10.00000 mA	500 nA	0.020% + 1.5 μA	40 nA	10 nA <100 μV	0.020% + 600 nA
100.0000 mA	5 μA	0.025% + 15 μA	100 nA	100 nA <100 μV	0.025% + 6 μA
1.000000 A	50 μA	0.067% + 900 μA	3 μA	1 μA <100 μV	0.030% + 500 μA

TEMPERATURE COEFFICIENT (0°–18°C and 28°–50°C): ±(0.15 × accuracy specification)/°C.

- Speed = 1 PLC.
- All specifications are guaranteed with output ON.
- Accuracies apply to 2- and 4-wire mode when properly zeroed.
- For sink mode, 1μA to 100mA range accuracy is ±(0.15% + offset × 4). For 1A range, accuracy is ±(1.5% + offset × 8).
- Rear panel triax connections only.

Resistance Measurement Accuracy (Local or Remote Sense)^{2,3}

Range	Default Resolution ⁶	Default Test Current	Normal Accuracy	Enhanced Accuracy ⁷
			(23°C ± 5°C) 1 Year, ±(% rdg. + ohms)	(23°C ± 5°C) 1 Year, ±(% rdg. + ohms)
<2.000000 Ω ⁸	1 μΩ	User defined	Source I _{ACC} + Meas. V _{ACC}	Meas. I _{ACC} + Meas. V _{ACC}
20.00000 Ω	10 μΩ	100 mA	0.098% + 0.003 Ω	0.073% + 0.001 Ω
200.0000 Ω	100 μΩ	10 mA	0.077% + 0.03 Ω	0.053% + 0.01 Ω
2.000000 kΩ	1 mΩ	1 mA	0.066% + 0.3 Ω	0.045% + 0.1 Ω
20.00000 kΩ	10 mΩ	100 μA	0.063% + 3 Ω	0.043% + 1 Ω
200.0000 kΩ	100 mΩ	10 μA	0.065% + 30 Ω	0.046% + 10 Ω
2.000000 MΩ	1 Ω	1 μA	0.110% + 300 Ω	0.049% + 100 Ω
20.00000 MΩ	10 Ω	1 μA	0.110% + 1 kΩ	0.052% + 500 Ω
200.0000 MΩ	100 Ω	100 nA	0.655% + 10 kΩ	0.349% + 5k Ω
>200.0000 MΩ ⁸	—	User defined	Source I _{ACC} + Meas. V _{ACC}	Meas. I _{ACC} + Meas. V _{ACC}

TEMPERATURE COEFFICIENT (0°–18°C and 28°–50°C): ±(0.15 × accuracy specification)/°C.

SOURCE CURRENT, MEASURE RESISTANCE MODE:

Total uncertainty = I_{source} accuracy + V_{measure} accuracy (4-wire remote sense).

SOURCE VOLTAGE, MEASURE RESISTANCE MODE:

Total uncertainty = V_{source} accuracy + I_{measure} accuracy (4-wire remote sense).

GUARD OUTPUT IMPEDANCE: 0.5Ω (DC) in ohms mode.

- 6.5 digit measure resolution
- Source readback enabled. Offset compensation ON.
- Source Current, Measure Resistance or Source Voltage, Measure Resistance only.

1.888.KEITHLEY (U.S. only)

www.keithley.com

A Greater Measure of Confidence

KEITHLEY
A Tektronix Company

OPERATING CHARACTERISTICS

MAX. OUTPUT POWER:	20W, four-quadrant source or sink operation.												
SOURCE LIMITS:	Vsource: ±21V (≤ 1A range), ±210V (≤ 100mA range) Isource: ±1.05A (≤ 20V range), ±105mA (≤ 200V range)												
OVERRANGE:	105% of range, source and measure.												
REGULATION:	Voltage: Line: 0.01% of range. Load: 0.01% of range + 100µV. Current: Line: 0.01% of range. Load: 0.01% of range + 100pA.												
SOURCE LIMITS:	Voltage Source Current Limit: Bipolar current limit set with single value. Min. 10% of range. Current Source Voltage Limit: Bipolar voltage limit set with single value. Min. 10% of range.												
V-LIMIT / I-LIMIT ACCURACY:	Add 0.3% of setting and ±0.02% of reading to base specification.												
OVERSHOOT:	Voltage Source: <0.1% typical (full scale step, resistive load, 20V range, 10mA I-Limit). Current Source: <0.1% typical (1mA step, R _{load} = 10kΩ, 20V range)												
RANGE CHANGE OVERSHOOT:	Overshoot into a fully resistive 100kΩ load, 10Hz to 20MHz BW, adjacent ranges: 250mV typical												
OUTPUT SETTLING TIME:	Time required to reach 0.1% of final value, 20V range, 100mA I-Limit: <200µs typical.												
MAXIMUM SLEW RATE:	0.2V/µs, 200V range, 100mA limit into a 2kΩ load (typical)												
OVER VOLTAGE PROTECTION:	User selectable values, 5% tolerance. Factory default = none.												
VOLTAGE SOURCE NOISE:	10Hz–1MHz (RMS): 2mV typical into a resistive load.												
COMMON MODE VOLTAGE:	250V DC.												
COMMON MODE ISOLATION:	>1GΩ, <1000pF.												
NOISE REJECTION (TYPICAL):	<table border="1"> <thead> <tr> <th>NPLC</th> <th>NMRR</th> <th>CMRR</th> </tr> </thead> <tbody> <tr> <td>0.01</td> <td>—</td> <td>60 dB</td> </tr> <tr> <td>0.1</td> <td>—</td> <td>60 dB</td> </tr> <tr> <td>1</td> <td>60 dB</td> <td>100 dB*</td> </tr> </tbody> </table> <p>* Except lowest two current ranges –90dB.</p>	NPLC	NMRR	CMRR	0.01	—	60 dB	0.1	—	60 dB	1	60 dB	100 dB*
NPLC	NMRR	CMRR											
0.01	—	60 dB											
0.1	—	60 dB											
1	60 dB	100 dB*											
LOAD IMPEDANCE:	20nF typical (standard). Stable into 50µF typical (High-C mode). High-C mode valid for ≥100µA ranges, ≥200mV ranges.												
MAX. VOLTAGE DROP BETWEEN FORCE and SENSE TERMINALS:	5V.												
MAX. SENSE LEAD RESISTANCE:	1MΩ for rated accuracy.												
SENSE INPUT IMPEDANCE:	>10GΩ.												
GUARD OFFSET VOLTAGE:	<300µV, typical												

System Measurement Speeds ⁹

READING RATES (READINGS/SECOND) TYPICAL FOR 60Hz (50Hz):

SCRIPT (TSP) Programmed

NPLC/Trigger Origin	Measure				Source-Measure Sweep			
	To Mem.	To GPIB	To USB	To LAN	To Mem.	To GPIB	To USB	To LAN
0.01 / Internal	3130 (2800)	2830 (2570)	2825 (2600)	2790 (2530)	1710 (1620)	1620 (1540)	1630 (1540)	1620 (1540)
0.01 / External	2170 (2050)	2150 (2030)	2170 (2040)	2160 (1990)	1670 (1590)	1580 (1500)	1590 (1510)	1580 (1510)
0.1 / Internal	540 (460)	530 (450)	530 (450)	530 (450)	470 (410)	460 (400)	470 (400)	470 (400)
0.1 / External	500 (430)	490 (420)	500 (430)	500 (420)	470 (400)	460 (390)	460 (400)	460 (400)
1.00 / Internal	59 (49)	58 (49)	59 (49)	59 (49)	58 (48)	58 (48)	58 (48)	58 (48)
1.00 / External	58 (48)	57 (48)	58 (48)	58 (48)	57 (48)	57 (47)	57 (48)	57 (48)

SCPI Programmed ¹⁰

NPLC/Trigger Origin	Measure				Source-Measure Sweep			
	To Mem.	To GPIB	To USB	To LAN	To Mem.	To GPIB	To USB	To LAN
0.01 / Internal	3130 (2800)	3060 (2760)	3000 (2790)	3010 (2710)	1710 (1630)	1610 (1600)	1440 (1380)	1690 (1590)
0.01 / External	2350 (2200)	2320 (2170)	2340 (2190)	2320 (2130)	1680 (1590)	1560 (1570)	1410 (1360)	1660 (1560)
0.1 / Internal	540 (460)	540 (450)	540 (460)	540 (450)	470 (410)	470 (410)	450 (390)	470 (410)
0.1 / External	510 (440)	510 (430)	510 (440)	510 (430)	470 (400)	470 (400)	450 (390)	470 (400)
1.00 / Internal	59 (49)	59 (49)	59 (49)	59 (49)	58 (48)	58 (48)	57 (48)	58 (48)
1.00 / External	58 (49)	58 (49)	58 (49)	58 (49)	58 (48)	58 (48)	57 (47)	58 (48)

⁹ Reading rates applicable for voltage or current measurements, autozero off, autorange off, filter off, binary reading format, and source readback off.
¹⁰ SCPI programming mode. Speeds do not apply to SCPI 2400 mode.

GENERAL CHARACTERISTICS (default mode unless specified)

FACTORY DEFAULT STANDARD POWER-UP: SCPI MODE.

SOURCE OUTPUT MODES: Fixed DC Level, Memory/Configuration List (mixed function), Stair (linear and log).

SOURCE MEMORY LIST: 100 points max. (SCPI 2400 Mode only).

MEMORY BUFFER: >250,000 readings. Includes selected measured value(s) and time stamp.

REAL-TIME CLOCK: Lithium battery backup (3 yr. + battery life).

REMOTE INTERFACES:

GPIB: IEEE-488.1 compliant. Supports IEEE-488.2 common commands and status model topology.

USB Device (rear panel, type B): 2.0 Full Speed USBTMC.

USB Host (front panel, type A): USB 2.0, support for flash drives, FAT32.

Ethernet: RJ-45 (10/100BT)

PROGRAMMABILITY: SCPI or TSP command sets.

TSP MODE: Embedded Test Script Processor (TSP) accessible from any host interface.

IP CONFIGURATION: Static or DHCP

EXPANSION INTERFACE: The TSP-Link expansion interface allows TSP enabled instruments to trigger and communicate with each other.

LXI COMPLIANCE: 1.4 LXI Core 2011.

DISPLAY: 5 inch capacitive touch, color TFT WVGA (800x480) with LED backlight.

INPUT SIGNAL CONNECTIONS: **Front:** Banana. **Rear:** Triaxial (3-Lug)

INTERLOCK: Active High Input

DIGITAL I/O INTERFACE:

Lines: 6 Input/Output user defined for digital I/O or triggering

Connector: 9-pin female D

Input Signal Levels: 0.7 V (maximum logic low), 3.7 V (minimum logic high)

Input Voltage Limits: -0.25 V (Abs. minimum), +5.25 V (Abs. maximum)

Maximum Source Current: +2.0 mA @ >2.7 V (per pin)

Maximum Sink Current: -50 mA @ 0.7 V (per pin, solid-state fuse protected)

5 V Power Supply Pin: Limited to 500 mA @ >4V (solid-state fuse protected)

Handler: User definable Start of Test, End of Test, 4 category bits

COOLING: Forced air, variable speed.

OVER TEMPERATURE PROTECTION: Internally sensed temperature overload puts unit in standby mode.

POWER SUPPLY: 100V to 240V RMS, 50–60Hz (automatically detected at power up).

VA RATING: 190 volt-amps max.

ALTITUDE: Maximum 2000 meters above sea level.

EMC: Conforms to European Union EMC Directive.

SAFETY: NRTL listed to UL61010-1 and UL61010-2-30. Conforms with European Union Low Voltage Directive.

VIBRATION: MIL-PRF-28800F Class 3 Random.

WARM-UP: 1 hour to rated accuracies.

DIMENSIONS: (With handle and bumpers): 106mm high × 255mm wide × 425mm deep (4.18 in × 10.05 in × 16.75 in). (Without handle and bumpers): 88mm high × 213mm wide × 403mm deep (3.46 in × 8.39 in × 15.87 in).

WEIGHT: With bumpers & handle: 4.04 kg (8.9 lbs.). Without bumpers & handle: 3.58 kg (7.9 lbs.).

ENVIRONMENT: Operating: 0°–50°C, 70% R.H. up to 35°C. Derate 3% R.H./°C, 35°–50°C.

Storage: –25°C to 65°C.

ACCESSORIES SUPPLIED: Test Leads, USB Cable, Ethernet/TSP Cable, Interlock Adapter, Power Cord, Quick Start Guide, CD User's Manual.

2450

SourceMeter® SMU Instrument

Model 2450 SourceMeter® SMU Instrument

SMU INSTRUMENTS

Specifications are subject to change without notice. All Keithley trademarks and trade names are the property of Keithley Instruments, Inc. All other trademarks and trade names are the property of their respective companies.

KEITHLEY

A Tektronix Company

A Greater Measure of Confidence

KEITHLEY INSTRUMENTS, INC. ■ 28775 AURORA RD. ■ CLEVELAND, OH 44139-1891 ■ 440-248-0400 ■ Fax: 440-248-6168 ■ 1-888-KEITHLEY ■ www.keithley.com

BENELUX

+31-40-267-5506
www.keithley.nl

FRANCE

+33-01-69-86-83-60
www.keithley.fr

ITALY

+39-049-762-3950
www.keithley.it

MALAYSIA

60-4-643-9679
www.keithley.com

SINGAPORE

01-800-8255-2835
www.keithley.com.sg

BRAZIL

55-11-4058-0229
www.keithley.com

GERMANY

+49-89-84-93-07-40
www.keithley.de

JAPAN

81-120-441-046
www.keithley.jp

MEXICO

52-55-5424-7907
www.keithley.com

TAIWAN

886-3-572-9077
www.keithley.com.tw

CHINA

86-10-8447-5556
www.keithley.com.cn

INDIA

080-30792600
www.keithley.in

KOREA

82-2-6917-5000
www.keithley.co.kr

RUSSIA

+7-495-664-7564
www.keithley.ru

UNITED KINGDOM

+44-1344-39-2450
www.keithley.co.ukw

For further information on how to purchase or to locate a sales partner please visit www.keithley.com/company/buy